

Submitted sir,

Sub: RWS&S-TDWSP- Nagaguda 40KL OHBR (25mtr) in Triyani Mandal-
Komarambheem Asifabad Segment-Adilabad District-Designs -Approval-Reg.

Kindly pursue the Designs of the following 40KL OHBR at Nagaguda (V), Triyani (M), submitted by the Executive Engineer TDWSP Asifabad Division, Adilabad district for approval.

1. 40 KL OHBR.

The Executive Engineer TDWSP Asifabad Division has submitted Structural Designs & Drawings of 40KL OHBR based on the field conditions and as per the estimate provisions , the structural designs & drawings for the above structure is verified and submitted for approval.

The following design parameters were considered:

- Capacity : 40kL
- Net SBC of Soil : 15.0 t/sqm
- Grade of concrete & Steel : M 30 & Fe 500
- Height of staging : ~~25~~ mts *25 mts*
- Dia of Shaft Inner to Inner : 4.75 mts
- Dia of Tank Inner to Inner : 4.75 mts
- Thickness of shaft : 250mm
- Top Slab thickness: 125mm
- Bottom Slab thickness : 250 mm
- Raft Slab thickness: 500mm *600mm*
- Depth of Foundation : 3.00 mts

As per the above parameters the structural design and drawings of the OHBR is verified, duly following IS codes, IS: 456-2000, SP: 16, 34, IS:3370 and IS 1893-2002 (seismic codes).The sizes and steel proposed in the designs and drawings of all components are safe and sufficient.

The additional points noted after checking the designs are:

- Detailed Estimate of the Structure with these specifications has to be prepared and compared with the provision made in sanctioned estimate. Such that deviation if any is within authorized limits. If any deviations noticed, the Estimate should be submitted for obtaining approval from the Competent Authority.

Subject to approval a draft memo addressed to the EE, TDWSP Asifabad Division , for Communicating approved Structure is put up for kind perusal and approval.

AEE (Designs)
TDWSP,Nirmal Circle

DEE (Designs)
TDWSP,Nirmal Circle

Superintending Engineer,
TDWSP,Nirmal Circle

A	For Approval	24.03.16	30.03.16	31.03.16
		AKHB <i>AB</i>	RR <i>[Signature]</i>	BRJ <i>[Signature]</i>
REV. NO.	DESCRIPTION	DESIGNED	CHECKED	APPROVED

REVISIONS



**LARSEN & TOUBRO LIMITED
CONSTRUCTION DIVISION**

Water, Smart World & Communication IC

CLIENT:

TELANGANA DRINKING WATER SUPPLY PROJECT,
GOVERNMENT OF TELANGANA

CONSULTANT :

PROJECT : Providing drinking water to habitations in Komarambheem-Asifabad Segment in Adilabad District

SUPPLIER / CONTRACTOR L&T CONSTRUCTION
Water & Effluent Treatment SBG

JOB Ref. No. : LE150883

TITLE :

	NAME	SIGN	DATE
DSGN	AKHB	<i>AB</i>	24.03.16
CHKD	RR	<i>[Signature]</i>	30.03.16
APPD	BRJ	<i>[Signature]</i>	31.03.16

40 KL capacity OHBR -25m staging height - Design Calculations

DOC./DRG. No.

L E 1 5 0 8 8 3 - C - W S - C W - D C - 3 0 0 3

SIZE
A4

REV.
A

RELEASED FOR

PRELIMINARY

INFORMATION

APPROVAL

CONSTRUCTION



PROJECT:	Providing drinking water to habitations in Komarambheem-Asifabad Segment in Adilabad District	DOCUMENT NO. LE150883-C-WS-CW-DC-3003		DATE 24/03/2016
TITLE :	40 KL Capacity OHBR - 25m staging height	DESIGNED AKHB/RRG	CHECKED RR	PAGE
Design of Over head Reservoir				
(1) DATA:				
	Capacity of Tank			40 m ³
	Unit weight of RCC=			25 kN/m ³
	Unit weight of PCC=			24 kN/m ³
	Unit weight of soil =			18 kN/m ³
	Unit weight of sand filling inside bottom of shaft =			18 kN/m ³
	Unit weight of water=			10 kN/m ³
	Staging Height			25 m
	Net S.B.C of Soil =			150 kN/m ²
(2) PERMISSIBLE STRESS:				
	Grade of concrete;	$f_{ck} =$	M30	N/mm ²
	Grade of steel;	$f_y =$	Fe500	N/mm ²
Ref Table 1 of IS:3370	Allowable stress as per IS:3370 relating to resistance to cracking			
	Allowable direct tensile stress in concrete			$\sigma_{at} =$ 1.5 N/mm ²
	Allowable bending tensile stress in concrete			$\sigma_{bt} =$ 2.0 N/mm ²
Ref Table 4 of IS:3370	Allowable stress in steel under direct tension, bending & shear = $\sigma_{st} =$			130 N/mm ²
	Allowable stress in steel under direct compression = $\sigma_{sc} =$			140 N/mm ²
				$\sigma_{st2} =$ 150 N/mm ²
IS 456:200	Allowable stress in steel under direct tension, bending & shear = $\sigma_{st} =$			230 N/mm ²
	Allowable stresses as per IS:456 for strength calculations			
Ref Table 21 of IS:456	Allowable direct compressive stress in concrete			$\sigma_{cc} =$ 8 N/mm ²
	Allowable bending compressive stress in concrete			$\sigma_{cbc} =$ 10 N/mm ²
	Modular ratio =	$m = \frac{280}{3\sigma_{cbc}} =$	m =	9.33
	Neutral axis co-efficient;	$n = \frac{m\sigma_{cbc}}{m\sigma_{cbc} + \sigma_{st}} =$	n =	0.42
	Lever arm coefficient;	$j = 1-n/3 =$	j =	0.86
	Moment coefficient =	$K=0.5 \times \sigma_{cbc} \times (n \times j) =$		1.81 N/mm ²
(3) Volume calculation				
	Diameter of tank, D =			5.00 m
	Rise of Top Dome, h =	=D/5	=5/5	1.00 m



PROJECT:	Providing drinking water to habitations in Komarambheem-Asifabad Segment in Adilabad District	DOCUMENT NO.		LE150883-C-WS-CW-DC-3003	DATE	24/03/2016
TITLE :	40 KL Capacity OHBR - 25m staging height	DESIGNED	AKHB/RRG	CHECKED	RR	PAGE
Diameter of supporting shaft = D =						5.00 m
Rise of bottom dome , h = =D/5	=5/5					1.00 m
Height of water column in cylindtical portion of tank, H =						3.25 m
Free board, F.B =						0.30 m
Total Height of tank wall = H+FB-(1.8-h)	=3.25+0.3+(1.8-1)					4.35 m
C/C Diameter of internal shaft						1.20 m
Outer Diameter of Internal shaft = (Dia+thk of wall)=	1.2+0.2					1.40 m
Radius of Inner Shaft =	=1.2/2					0.60 m
Total height of Internal shaft = H-h+FB=	=3.25-1+0.3					2.55 m
Inner diameter of the tank = D-shaft thk+(wall thk/2)	=5-0.25+(0.25/2)					4.75 m
Volume of Cylindrical portion =V ₁ = (π/4)×(inner dia) ² ×H =	(π/4)×(4.75) ² ×3.25					57.59 m ³
Radius of curvature of bottom dome = R =[(D/2) ² +h ²]/(2h)						
	=[(5/2) ² +1 ²]/(2×1)					3.63 m
Volume of bottom dome =V ₂ = (π/3)×(r ² ×(3R-h))						
	=(π/3)×(1 ² ×(3×3.63-1))					10.36 m ³
Volume of internal shaft =V ₃ = (π/4)×(dia ² ×(H-h))						
	=(π/4)×[1.4 ² ×(3.25-1)]					3.46 m ³
Total volume of tank without free board = V ₁ -V ₂ -V ₃	=57.59-10.36-3.46					43.77 m ³
						OK
Total volume of tank with free board =						48.63 m ³
(4) Design of Top dome:						
<p>The diagram illustrates a spherical dome structure. A vertical dashed line represents the axis of symmetry. The height of the dome from the horizontal chord to the apex is 1.00. The radius of curvature of the dome is 3.63. The horizontal distance from the vertical axis to the edge of the dome is 2.50. The angle between the vertical axis and the radius line is labeled as θ = 43.53°. The dome is supported by a horizontal shaft with a diameter of 1.25.</p>						
Figure 2: Top Dome.						
Radius of the chord, r =	5/2					2.50 m



PROJECT:	Providing drinking water to habitations in Komarambheem-Asifabad Segment in Adilabad District	DOCUMENT NO.		LE150883-C-WS-CW-DC-3003	DATE	24/03/2016
TITLE :	40 KL Capacity OHBR - 25m staging height	DESIGNED	AKHB/RRG	CHECKED	RR	PAGE
	Rise of the top dome, h =					1.00 m
	Radius of the shell surface = $(r^2 + h^2)/2h =$		$(2.5^2 + 1^2)/(2 \times 1)$			3.63 m
	Semi-central angle is given by					
	$\sin \theta = r_3/R =$	0.69	that is,	$\theta =$	43.53°	
				=	0.760 rad	
	Thicknes of the dome =					125 mm
	Self weight of dome (wg) = 0.125 X 25					3.125 kN/m ²
	Live load w _l =					1.50 kN/m ²
	Total load, w =	= 1.5 + 3.125 =				4.63 kN/m ²
	Weight of the dome = $2\pi R h w_g =$		$2\pi \times 3.63 \times 1 \times 3.125 =$			71.27 kN
	Live load on the dome = $2\pi R h w_l =$		$2\pi \times 3.63 \times 1 \times 1.5 =$			34.21 kN
	Total load on top dome =		$71.27 + 34.21 =$			105.48 kN
	Meridional thrust = $N_\theta = (wR)/(1+\cos \theta) =$					9.73 kN/m
		Meridional Stress = $0.00973/0.125 =$				0.08 MPa
						0.08 < 1.5 (OK)
	As the stress is only nominal, provide the min. reinforcement of					0.24 %
		$A_{sm} = 0.24 \times (125) \times (1000)/100$				300.00 mm ² /m
	Dia of bar =					10
	Spacing of bar required =					260 mm
		Provide 10 mm dia bar @ 125 mm c/c in meridional direction				
	Circumferential force = $wR[\cos \theta - (1/(1+\cos \theta))] =$					2.44 kN/m
		Hoop stress =	$0.00244/0.0015$			0.02 MPa
						0.02 < 1.5 (OK)
	As the stress is only nominal, provide the min. reinforcement of					0.24 %
		$A_{sm} = 0.24 \times (125) \times (1000)/100$				300.00 mm ² /m
	Dia of bar =					10 mm
	Spacing of bar required =					260 mm
		Provide 10 mm dia bar @ 125 mm c/c in circumferential direction				
(5)	Design of beam at balcony level and balcony slab					
	<u>Design of balcony</u>					
	Clear width of walkway					0.75 m
	Width of beam at this level					350 mm
	Cantilever span of balcony from beam					0.40 m



PROJECT:	Providing drinking water to habitations in Komarambheem-Asifabad Segment in Adilabad District	DOCUMENT NO.		LE150883-C-WS-CW-DC-3003	DATE	24/03/2016
TITLE :	40 KL Capacity OHBR - 25m staging height	DESIGNED	AKHB/RRG	CHECKED	RR	PAGE
Thickness of slab						150 mm
Self weight of slab	$= (0.15) \times 25 \times 0.4 =$					1.50 kN/m
Live load on slab						1.50 kN/m ²
Load due to finishes						1.20 kN/m ²
Total load acting on the walkway slab	$= 0.15 \times 25 + 1.5 + 1.2 =$					6.45 kN/m ²
Max BM at Support	$= 6.45 \times 0.4^2 / 2 =$					0.52 kN-m
Effective Depth required	$= \sqrt{((BM \times 10^6) / (k \times 1000))} = \sqrt{((0.52 \times 10^6) / (1.81 \times 1000))}$					16.97 mm
Provided 150 mm uniform thickness for walkway slab						
Cover to the reinforcement						25 mm
Diameter of bar						12 mm
effective depth provided	$= 150 - 25 - 12$					119 mm
Area of steel required	$= (0.52 \times 10^6) / (0.86 \times 119 \times 130)$					39.09 mm ² /m
Minimum percentage of steel required	$=$					0.24 %
Minimum Area of steel required on center of slab	$= 0.0024 \times 150 \times 1000 =$					360.00 mm ² /m
Spacing of 12 mm dia steel	$=$					250 mm c/c
Spacing provided	$=$					200 mm c/c
Area of steel provided	$=$					565.49 mm ² /m
percentage of steel provided	$=$					0.48
Diameter of distribution bar	$=$					10 mm
Spacing of 10 mm dia tor steel	$=$					200 mm c/c
10 mm dia tor steel @ 200 mm c/c as distribution steel						
Provide 12 mm main bar @ 200 mm c/c						
Total weight of slab	$= 2 \times \pi \times (5/2 + 350/1000 + 0.4/2) \times 0.4 \times (150/1000) \times 25$					28.75 kN
(6) Design of Top ring Beam						
Hoop thrust on ring beam is same as the horizontal component of the meridional thrust from the top dome. The hoop tension in the ring beam is, therefore, equal to						
Hoop Tension	$= T = N_0 \cos(\theta) R =$					17.64 kN
				Where R =		2.50 m
Size of the web of the ring beam:						
		b =				350 mm
		D =				300 mm



PROJECT:	Providing drinking water to habitations in Komarambheem-Asifabad Segment in Adilabad District	DOCUMENT NO.		LE150883-C-WS-CW-DC-3003	DATE	24/03/2016
TITLE :	40 KL Capacity OHBR - 25m staging height	DESIGNED	AKHB/RRG	CHECKED	RR	PAGE
	Area of tension steel required, $A_s =$	$= (17.64 \times 1000) / 130$			135.692	mm^2
	Minimum percentage of steel =				0.24	%
	Minimum steel $A_{\min} =$	$= (0.0024) \times 350 \times 300$			252.00	mm^2
	Cover to the reinforcement =				25	mm
	Dia of bar =				16	mm
	Number of bars required				2	Nos.
	Number of bars provided				3	Nos.
	Area of steel provided =				603	mm^2
	Stress in concrete = $T / [A_g + (m-1)A_{st}] =$					
	$= (17.64 \times 1000) / [(350 \times 300) + (9.33-1) \times 603.19] =$				0.16	N/mm^2
					0.16 < 1.5 (Safe)	
	Provide a ring beam of size 350 mm by 300 mm.					
	Provide 3Y16 at top and 3Y16 at bottom					
	Provide 8 mm dia stirrups at 250 mm centres.					
	Self weight of beam = $2\pi (2.675) (0.35 \times 0.3) (25) =$				44.12	kN
	(7) Design of vertical wall of tank					
	Total Wall height =				4.35	m
	height of water column =	$= 3.25 + 0.3 =$			3.55	m
	Radius of tank				2.50	m
	Hoop tension, $T =$	unit weight of water $\times H \times D/2$	$= 10 \times 3.55 \times 2.5$		88.75	kN/m
	Thickness of wall =				250	mm
		$H^2/Dt =$	$= 4.35^2 / (4.75 \times 0.25)$		15.93	
	Calculating tension and moment from IS 3770 Part 4					
From IS 3370	Hoop tension for hinged base and top free					
	Coefficient from table 9 of IS 3370 Part 4					0.77522
	Hoop tension	$= \text{coefficient} \times w \times H \times R$	$= 0.78 \times 10 \times 4.35 \times 2.5$		84.3048	kN/m
	Maximum Hoop tension, $T =$				88.8	kN/m
	A_{st} required on each face for max tension =	$= 88.75 \times 1000 / (130 \times 2)$			341.35	mm^2
	Minimum A_{st} required as per IS 3370				0.24	%
	A_{st} minimum required on each face	$= (0.0024 \times 1000 \times 250) / 2$			300	mm^2
	Dia of bar provided =				10	mm
	Spacing required on each face				230	mm



PROJECT:	Providing drinking water to habitations in Komarambheem-Asifabad Segment in Adilabad District	DOCUMENT NO. LE150883-C-WS-CW-DC-3003		DATE 24/03/2016
TITLE :	40 KL Capacity OHBR - 25m staging height	DESIGNED AKHB/RRG	CHECKED RR	PAGE
Provide 10 mm dia @ 145 mm centres on both faces				
Area of steel provided				541.65 mm ²
Stress in concrete = $T/[A_g + (m-1)A_{st}] =$ $=(88.75 \times 1000)/(1000 \times 250 + (9.33-1) \times 541.65)$				0.35 N/mm ²
0.35 < 1.5 (Safe)				
Vertical Steel				
From IS 3370	Vertical Moment for Fixed base and top free			
	Coefficient from table 10 of IS 3370 Part 4			0.00794
Moment		= coefficient x w x H ³	= 0.0079 x 10 x 4.35 ³	6.53226 kN-m
Area of steel required for moment				
				$= 6.53 \times 10^6 / (130 \times (250 - 45 - 12/2) \times 0.86)$
Minimum area of steel on each face				300 mm ²
Diameter of bar provided				12 mm
Spacing required				250 mm
Spacing provided				200 mm
Provide 12 mm dia @ 200 mm centres on both faces				
Area of steel provided = $(\pi/4) \times 12^2 \times (1000/250)$				565.49 mm ²
Total weight of cylindrical wall = $2 \times \pi \times 2.5 \times 4.35 \times 0.25 \times 25$				427.06 kN
(8) Design of bottom dome and internal shaft				
Figure 4: Bottom Dome.				



PROJECT:	Providing drinking water to habitations in Komarambheem-Asifabad Segment in Adilabad District	DOCUMENT NO.		LE150883-C-WS-CW-DC-3003	DATE	24/03/2016
TITLE :	40 KL Capacity OHBR - 25m staging height	DESIGNED	AKHB/RRG	CHECKED	RR	PAGE
Diameter at base of dome =					5.00	m
Rise of bottom dome = h =					1.00	m
Thickness of bottom dome, t =					250	mm
Radius of the shell surface = $(radius^2 + rise^2)/(2 \times rise) =$					3.63	m
Weight of the dome slab = $2 \times \pi \times 3.63 \times 1 \times 0.25 \times 25 =$					142.55	kN
Thickness of walls of Internal shaft =					200	mm
Total Projection of platform required at top of internal shaft					750	mm
Thickness of platform					150	mm
Internal diameter of vertical shaft =	$= (2 \times 0.6) - 0.2$				1000	mm
External diameter =	$1000 + 2 \times 200 =$				1400	mm
Weight of water over bottom dome = (with FB)	$= 48.63 \times 10$				486.3	kN
Weight of vertical shaft = $= \pi \times ((1400 - 200)/1000) \times (200/1000) \times 2.55 \times 25$					48.07	kN
Weight of circular platform						
	$= \pi \times (1000/1000 + 750/1000) \times (150/1000) \times (750 - 200)/1000 \times 25$				11.34	kN
Total weight on dome =	$= 142.55 + 486.26 + 48.07 + 11.34$				688.21	kN
Load/unit area = w =	$= 688.21 / ((\pi/4) \times 5^2)$				35.05	kN/m ²
Meridional thrust = $T_1 =$	$= wR / (1 + \cos \theta)$				73.78	kN
	where, $\cos \theta =$				0.725	rad
Meridional stress =	$(73.78 \times 1000) / (130 \times 1000) =$				0.568	N/mm ²
					0.568 < 8 (Safe)	
Circumferential force = $wR [\cos \theta - 1 / (1 + \cos \theta)] =$					18.4	kN
Hoop stress =	$(18.4 \times 1000) / (130 \times 1000) =$				0.14	N/mm ²
					0.14 < 1.5 (Safe)	
Provide minimum reinforcement of					0.24	%
Minimum steel required, $A_{st} =$					600	mm ²
Diameter of bar provided =					10	mm
Spacing of bar required =					125	mm
Provide 10 mm dia bar at 125 mm centres both radially and in circumferential direction.						
Maximum hoop compression in the internal shaft =						
	$= 10 \times 2.55 \times ((1400 - 200)/1000) / 2 =$				15.3	kN
Hoop stress =	$= (15.3 \times 1000) / (130 \times 1000) =$				0.12	N/mm ²
					0.12 < 8 (Safe)	
Provide minimum reinforcement of					0.24	%



PROJECT:	Providing drinking water to habitations in Komarambheem-Asifabad Segment in Adilabad District	DOCUMENT NO.		LE150883-C-WS-CW-DC-3003	DATE	24/03/2016	
TITLE :	40 KL Capacity OHBR - 25m staging height	DESIGNED	AKHB/RRG	CHECKED	RR	PAGE	
	Minimum steel required, $A_{st} =$				480	mm^2	
	Diameter of bar provided =				10	mm	
	Spacing of bar required =				160	mm	
	Provide 10 mm dia bar at 160 mm centres in both directions.						
	(9) Design of bottom ring beam						
	Horizontal thrust from bottom dome =	$=73.78 \times \text{COS}(43.53)$			53.45	kN	
	Net Hoop Tension force in ring beam, H =				53.45	kN	
	Hoop compression =	$= 53.45 (5/2) =$			133.63	kN	
	Dimensions of bottom ring beam :						
		b =			350	mm	
		D =			400	mm	
	Area of tension steel required	$=(133.625 \times 1000)/130$			1027.88	mm^2	
	Provide minimum reinforcement of				0.24	%	
	Minimum steel required, $A_{st} =$	$=(0.24/100) \times 350 \times 400$			336	mm^2	
	Diameter of bar provided =				16	mm	
	Number of bars required =				6	Nos.	
	Area of tension steel provided				1206	mm^2	
	Stress in concrete =	$T/[A_g + (m-1)A_{st}] =$					
		$=(133.625 \times 1000)/(350 \times 400 + (9.33-1) \times 1206.37$			0.89	N/mm^2	
					0.89 < 1.5 (Safe)		
	Provide a ring beam of size 350 mm by 400 mm.						
	Provide 3Y16 at top and 3Y16 at bottom						
	Provide 8 mm dia stirrups at 200 mm centres.						
	Weight of bottom ring beam =	$\pi \times 5 \times (0.35 \times 0.4) \times 25 =$			54.98	kN	
	(10) Design of supporting cylindrical shaft						
	Centre to centre Diameter of shaft =				5.00	m	
	Height of shaft (above G.L.) =				25	m	
	Thickness of shaft wall above G.L. =				250	mm	
	Minimum thickness of shaft required as per IS: 11682-1985				150	mm	
	Total depth of foundation below G.L. =				3.00	m	
	Depth of shaft (below G.L.) =	$= 3 - 0.6 =$			2.40	m	
	Thickness of shaft wall below G.L. =				350	mm	



PROJECT:	Providing drinking water to habitations in Komarambheem-Asifabad Segment in Adilabad District	DOCUMENT NO.		DATE
		LE150883-C-WS-CW-DC-3003		24/03/2016
TITLE :	40 KL Capacity OHBR - 25m staging height	DESIGNED	CHECKED	PAGE
		AKHB/RRG	RR	
	Self weight of shaft above G.L.	$= \pi \times 5 \times 25 \times 25 \times 0.25 =$		2454.37
	Self weight of shaft below G.L.	$= \pi \times 5 \times 25 \times 2.4 \times 0.35 =$		329.87 kN
	Thickness of shaft wall above G.L. =			250 mm
	Loads acting on shaft at ground level:			
	(1) Top dome			105.48 kN
	(2) Top ring beam			44.12 kN
	(3) Balcony			28.75 kN
	(4) Tank wall			427.06 kN
	(5) Bottom spherical dome			142.55 kN
	(6) Internal shaft + platform			59.41 kN
	(7) Bottom ring beam			54.98 kN
	Weight of tank portion =			862.34 kN
	(8) Supporting shaft			2784.24 kN
	Total Dead load on top of footing =			3646.58 kN
	(9) Weight of water (Hydro test condition)=			486.26 kN
	(10) Weight of water (Working condition)=			437.71 kN
	Wind pressure:			
	Basic wind speed, $V_b =$			50 m/s
	Risk Coefficient, $k_1 =$			1.08
	Terrain, height and structure size factor, $k_2 =$			1.11
	Topography factor, $k_3 =$			1
	Design wind speed, $V_z = V_b \times k_1 \times k_2 \times k_3 =$			59.94 m/s
	$P_z = 0.6 V_z^2 =$			2.16 kN/m ²
Ref Pg.	Total moment due to wind load about base of footing , M			2021.53 kN-m
Wind load calculation	Area of cross section of shaft, $A =$	$\pi [(2.625)^2 - (2.375)^2] =$		3.93 m ²
	Second moment of area, $I :$			
		$I = (\pi/4) [(2.625^4) - (2.375^4)] =$		12.30 m ⁴
	Stress at base section:			
	Tank empty condition:			
	$W =$			3646.58 kN
	Outer dia of shaft, $D =$			5.35 m
	Mean radius of shaft, $r =$			2.5 m
	$M =$			2021.53 kN-m
	$e = (M/W) =$			0.55 m



PROJECT:	Providing drinking water to habitations in Komarambheem-Asifabad Segment in Adilabad District	DOCUMENT NO. LE150883-C-WS-CW-DC-3003		DATE 24/03/2016
TITLE :	40 KL Capacity OHBR - 25m staging height	DESIGNED AKHB/RRG	CHECKED RR	PAGE
	$e/r =$	$0.55/2.5 =$		0.22 m
		$e/r \leq 1/2$ (OK)		
IS 11682-	<i>This section is under compression only</i>			
1985	$\sigma_{cv} = (W/2\pi r t)[1 + (2e/r)] =$			0.96 N/mm ²
	$0.96 < 0.38 \times 30$ (Safe)			
	<i>Tank working condition + wind:</i>			
	P =			4084.29 kN
	M =			2021.53 kN-m
	e = M/W =			0.49 m
	$e/r =$			0.2
IS 11682-	$e/r \leq 1/2$ (OK)			
1985	$\sigma_{cv} = (W/2\pi r t)[1 + (2e/r)] =$			1.03 N/mm ²
	$1.03 < 0.38 \times 30$ (Safe)			
	<i>Tank Hydro test condition</i>			
	W =			4132.84 kN
	M =			0 N-mm
	e = M/W =			0
IS 11682-	$\sigma_{cv} = (W/2\pi r t)[1 + (2e/r)] =$			0.75 N/mm ²
1985	$0.75 < 0.38 \times 30$ (Safe)			
IS 11682-	Provide minimum longitudinal reinforcement of			0.25 %
1985	Area of steel required on each face, $A_{st} =$			312.5 mm ²
	Diameter of bar provided =			12 mm
	≥ 10 mm (OK)			
	Spacing of bar required =			360 mm
	Spacing of bar provided =			200 mm
	Provide 12 mm dia bar at 200 mm centres vertically on each faces.			
	Area of steel provided on each face =			565.5 mm ²
	<i>Circumferential reinforcement in shaft:</i>			
IS 11682-	Provide minimum circumferential reinforcement of			0.2 %
1985	Area of steel required on each face, $A_{st} =$			250 mm ²
	Minimum steel required per meter length on each face =			200 mm ²
	Diameter of bar provided =			10 mm
	Spacing of bar required =			310 mm



PROJECT:	Providing drinking water to habitations in Komarambheem-Asifabad Segment in Adilabad District	DOCUMENT NO.		DATE
TITLE :	40 KL Capacity OHBR - 25m staging height	DESIGNED	CHECKED	PAGE
		AKHB/RRG	RR	
	Spacing of bar provided =			200 mm
	Area of steel provided per metre length of shaft=			392.70 mm ²
				> 200 (OK)
	Provide 10 mm dia bar at 200 mm centres circumferentially on each faces.			
	Area of steel provided =			392.7 mm ²
	<i>Check for seismic forces</i>			
	Height of staging above ground level =			25.00 m
	Stiffness of shaft, $k = 3 EI/l^3 =$			
IS 456-2000	$E = 5000(f_{ck})^{0.5} =$			27386.13 N/mm ²
	$I = (\pi/4) [(2.625^4) - (2.375^4)] =$			12.30 m ⁴
	$l =$ length of staging =			25.00 m
	$k =$			64690.85 kN/m
	Seismic coefficient is given by :	$A_h = \frac{Z I}{2 R} \left(\frac{S_a}{g} \right)$		
IS: 1893-2002	where, Zone Factor, Z =			0.1
	Importance Factor, I =			1.75
	Response reduction Factor R =			3
	Spectral Acceleration, (S_a/g)			
	Tank Empty condition :			
	Weight of tank Container =			862.34 kN
	Weight of 1/3 of staging = $(1/3) \times (2454.37) =$			818.12 kN
	Seismic weight for tank empty condition, $W_s =$			1680.46 kN
	Time period when tank empty, $T_e =$	$2\pi [(W_s/9.81) / k]^{0.5}$		
	$= 2\pi \times \{(1680.46/9.81)/(64690.85)\}^{0.5} =$			0.32 sec
IS: 1893-2002	For rocky, or hard soil sites, corresponding $S_a/g =$			2.50
	The design horizontal seismic coefficient, $A_h =$			0.07
	Maximum horizontal seismic force acting at top of staging =			122.53 kN
	<i>Moment due to seismic forces at top of footing:</i>			
	Total load, W =			3646.58 kN
	Moment, M=			3357.42 kN-m
	$e = M/W =$			0.92 m
	$e/r =$	$0.92/2.5 =$		0.37



PROJECT:	Providing drinking water to habitations in Komarambheem-Asifabad Segment in Adilabad District	DOCUMENT NO. LE150883-C-WS-CW-DC-3003		DATE 24/03/2016
TITLE :	40 KL Capacity OHBR - 25m staging height	DESIGNED AKHB/RRG	CHECKED RR	PAGE
IS 11682-1985	$e/r \leq 1/2$ (OK)			
	$\sigma_{cv} = (W/2\pi r t)[1 + (2e/r)] =$			1.15 N/mm ²
	1.15 < 0.40 x 30 (Safe)			
	<i>Tank Full condition :</i>			
	Weight of tank Container =			862.34 kN
	Weight of 1/3 of staging = (1/3) x (2454.37) =			818.12 kN
	Weight of water =			437.71 kN
	Seismic weight for tank full condition =			2118.18 kN
	Time period when tank full, T =			0.36 sec
IS: 1893-2002	For rocky, or hard soil sites, corresponding Sa/g =			2.5
	The design horizontal seismic coefficient, A _h =			0.07
	Maximum horizontal seismic force acting at top of staging =			154.45 kN
	<i>Moment due to seismic forces at top of footing:</i>			
	Total load, W =			4084.29 kN
	Moment, M= =154.45*(25+2.4)			4231.94 kN-m
	e= M/W =			1.04
	e/r = 1.04/2.5 =			0.42
IS 11682-1985	$e/r \leq 1/2$ (OK)			
	$\sigma_{cv} = (W/2\pi r t)[1 + (2e/r)] =$			1.36 N/mm ²
	1.36 < 0.40 x 30 (Safe)			
	<i>Check for stress at openings:</i>			
	<i>Size of opening :</i>	width =	1 m	
		height =	2 m	
	<i>Maximum vertical compressive stress in concrete at outside diameter of shaft shell is given by :</i>			
IS 11682-1985	$\sigma_{cv} = \frac{W}{2(\pi - \beta) r t} \left[1 + \frac{2 \left\{ \frac{e}{r} + \frac{\sin \beta}{\pi - \beta} \right\} \{ (\pi - \beta) \cos \beta + \sin \beta \}}{(\pi - \beta) - \frac{1}{2} \sin 2\beta - \frac{2 \sin^2 \beta}{(\pi - \beta)}} \right]$			



PROJECT :	Providing drinking water to habitations in Komarambheem-Asifabad Segment in Adilabad District	DOCUMENT NO.		DATE
		LE150883-C-WS-CW-DC-3003		24/03/2016
TITLE :	40 KL Capacity OHBR - 25m staging height	DESIGNED	CHECKED	PAGE
		AKHB/RRG	RR	

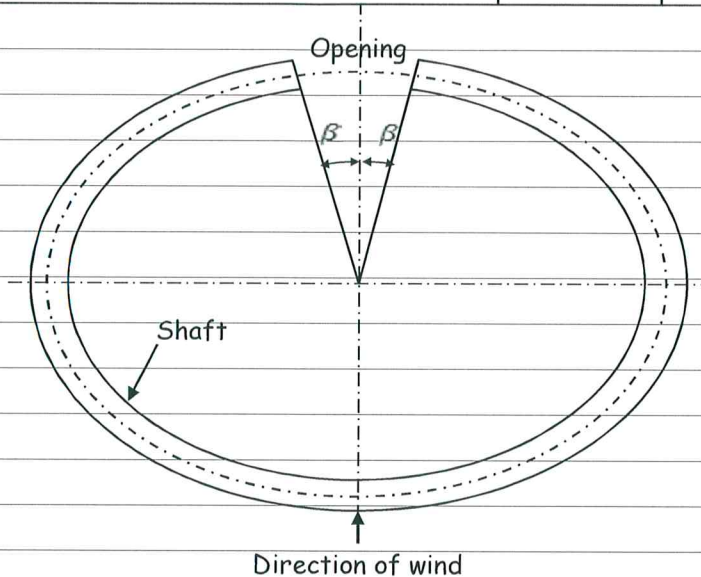

Where,

β = half the angle subtended by neutral axis as a chord on the circle of radius r =	0.20 rad
W = Total vertical load above section under consideration in N =	4084 KN
M = Moment in vertical plane at the section under consideration in N-mm =	4.23E+03 KN-m
$e = M/W =$	1.036 m
r = Mean radius of circular shaft in m =	2.5 m
t = Thickness of shaft in mm =	250 mm
$e/r =$	0.414
IS 11682-1985	From Table 1
	2.6 < 0.40 × 30 (Safe)

(11) Design of raft foundations

	Total load from tank and shaft = (Dead load on top of footing + weight of water working condition)	
	= 3646.58KN + 437.71KN	- (a) 4084.29 kN
From staad	Total weight of staircase =	1060 kN
	Load from staircase =	- (b) 1060 kN
	Diameter of raft slab, $D_r =$	8.1 m
	Thickness of raft slab, $t =$	600 mm
	Self weight of footing = $(\pi/4) \times D_r^2 \times t =$	



PROJECT:	Providing drinking water to habitations in Komarambheem-Asifabad Segment in Adilabad District	DOCUMENT NO.		LE150883-C-WS-CW-DC-3003	DATE	24/03/2016
TITLE :	40 KL Capacity OHBR - 25m staging height	DESIGNED	AKHB/RRG	CHECKED	RR	PAGE
	$= (\pi/4) \times 8.1^2 \times 0.6 \times 25$				- (c)	772.95 kN
	Weight of Earth filling inside the shaft upto G.L.					
	$= [\pi (4.65^2)/4] \times 2.4 \times 18 =$				- (d)	733.63 kN
	Weight of earth filling over the raft slab upto G.L.					
	$= [\pi (8.1^2 - 5.35^2)/4] \times 2.4 \times 18 =$				- (e)	1254.96 kN
	Total load acting on raft slab, W =				=(a)+(B)+(c)+(D)+(e)	7905.83 kN
	Net S.B.C. of soil =					150 kN/m ²
	Gross S.B.C at depth of 3 m below G.L. (For normal load)=					
	$= 150 + 3 \times 18$					204 kN/m ²
	Gross S.B.C at depth of 2.4 m below G.L. (For seismic/wind load)=					
	$= 150 + 1.25 \times 3 \times 18$					241.5 kN/m ²
	Area of footing, A =				$= (\pi/4) \times 8.1^2$	51.53 m ²
	Direct load, W =					7905.83 kN
	Moment M = (Tank full condition under seismic)					4231.94 kN-m
From staad	Moment from staircase column (seismic case) =					40.00 kN-m
	Total moment =					4271.94 kN-m
	Section modulus, Z=					52.17 m ⁴
	Maximum intensity of soil pressure at base = $[W/A + M/Z] =$					235.31 kN/m ²
	235.31 < 241.5 (Safe)					
	Minimum intensity of soil pressure at base = $[W/A - M/Z] =$					71.54 kN/m ²
	71.54 > 0 (No tension)					
	Adopt Diameter of raft slab = 8.1 m					
	Projection of raft beyond face of shaft =					1.375 m
	Maximum net soil pressure, w =					
	$= 235.31 - (600/1000 \times 25) - (18 \times 2.4)$					177.11 kN/m ²
	The loading at base is taken as annular loading on the mean diameter of the shaft.					
	Diameter of raft slab = 2a =					8.1 m
	Diameter of the shaft = 2b =					5.00 m
	Radial moment at centre of foundation is given by:					
	$M_r = \frac{W}{8\pi} \left[2 \log_e \left(\frac{a}{b} \right) + 1 - \left(\frac{b}{a} \right)^2 \right] - \frac{3}{16} w \cdot a^2$					= -46.49 kN-m/m
	Moment at junction of footing and tank walls at a radius of 2.5 m is given by:					



PROJECT:	Providing drinking water to habitations in Komarambheem-Asifabad Segment in Adilabad District	DOCUMENT NO.		LE150883-C-WS-CW-DC-3003	DATE	24/03/2016
TITLE :	40 KL Capacity OHBR - 25m staging height	DESIGNED	AKHB/RRG	CHECKED	RR	PAGE
	$M_{max} = \frac{W}{8\pi} \left[2 \log_e \left(\frac{a}{b} \right) + 1 - \left(\frac{b}{a} \right)^2 \right] - \frac{3}{16} w (a^2 - b^2) =$					161.06 kN-m/m
	Design ultimate moment = $M_{ur} =$		(1.5 x 161.06) =			241.59 kN-m/m
	Effective depth required $d = [M_u / .133 f_{ck} b]^{0.5} =$					246.07 mm
	Effective depth provided at the section =					542.00 mm
						(OK SAFE)
	Compute parameter:					
			$M_u / bd^2 =$			0.822
	Refer Table-4 of SP : 16 and read out the percentage reinforcement as:					
			$p_t = 100 A_{st} / bd =$			0.19528
			Area of steel required, $A_{st} =$			1058.42 mm ² /m
	Diameter of bar provided =					16 mm
	Cover to the reinforcement =					50 mm
	Actual effective depth at the section =					542
	Spacing of bar required =					175 mm
	Provide 16 mm dia bar at 175 mm centres both ways at bottom of footing.					
	Area of steel provided =					1148.93 mm ² /m
	Design ultimate moment = $M_{uc} =$		(1.5 x -46.49) =			-69.735 kN-m/m
	Compute parameter:					
			$M_u / bd^2 =$			0.24
	Refer Table-4 of SP : 16 and read out the percentage reinforcement as:					
			$p_t = 100 A_{st} / bd =$			0.12
			Area of steel required, $A_{st} =$			652.80 mm ² /m
	Diameter of bar provided =					12 mm
	Cover to the reinforcement =					50 mm
	Effective depth at the section =					544
	Spacing of bar required =					150 mm
	Provide 12 mm dia bar at 150 mm centres both ways at top of footing.					
	<i>Check for shear :</i>					

CALCULATION OF STRESSES IN SHAFT SECTION AT BASE OF SHAFT
 (As per Clause 8.2.5.2 of IS:11682-1985)
 Tank Operating condition+SL - Table-1

LEVEL	Width of opening (m)	Grade of concrete	ID m	thk m	Axial load (KN)	Moment KN-m	BETA β (Deg)	ALPHA α (Rad)	BETA (Rad)	Modular ratio (m)
0.000	1.000	30	4.75	0.250	4084.3	4231.94	11.31	2.530727	0.1973954	9.3300

p	ALPHA (assumed) (Deg)	e m	e/r	A	B	A/B	σ_{cv} N/mm ²	σ_{sy} N/mm ²
0.0025	145	1.03615	0.41	0.807367823	1.969507363	0.41	2.519 < 12 ok	2.361 < 249 ok

$$(e/r - A/B) = 0.00000$$

mp	1-p+mp	1-p	$\sin \alpha \cos \alpha$	$\sin \beta \cos \beta$	$\sin \alpha$	$\alpha \cos \alpha$	$\sin \beta$	$\beta \cos \alpha$	mp. π .cos α
0.023325	1.020825	0.9975	-0.46984631	0.192307538	0.573576	-2.07305	0.196116	-0.1616968	-0.06002548
			A	B	B'				
			0.807367823	1.969507	4.669543				



PROJECT:	Providing drinking water to habitations in Komarambheem-Asifabad Segment in Adilabad District	DOCUMENT NO. LE150883-C-WS-CW-DC-3003	DATE 24/03/2016
TITLE:	40 KL Capacity OHBR - 25m staging height	DESIGNED AKHB/RRG	CHECKED RR PAGE
Wind Load Calculation:			
Basic Wind Speed V_b (m/s) =		50	m/s
Risk Coefficient K_1 =		1.08	
Terrain Factor K_2 (For Category-1 & Class-B) =		1.11	
Topography factor K_3 =		1	
Design Wind Speed $V_z = V_b \times K_1 \times K_2 \times K_3 =$		59.94	m/s
Design Wind Pressure acting $P_z = 0.6 \times V_z^2 =$		2155.68	N/m ²
		2.16	kN/m ²
External Pressure Coefficient on shaft and top Cylindrical wall of bowl:			
Refer Table-18 (IS: 875 (Part-3) - 1987)			
Height of the Tank above ground level (h) =		27.175	m
Outer Diameter of the shaft (D) =		5.25	m
Ratio h/D = $27.175/5.25 =$		5.18	
From Table-18 use the coefficients for the nearest curve of h/D =7			



PROJECT:	Providing drinking water to habitations in Komarambheem-Asifabad Segment in Adilabad District	DOCUMENT NO. LE150883-C-WS-CW-DC-3003	DATE 24/03/2016
TITLE:	40 KL Capacity OHBR - 25m staging height	DESIGNED AKHB/RRG	CHECKED RR
	θ in degrees	Shaft (C_{pe})	Wall (C_{pe})
	0	1	1
	15	0.8	0.8
	30	0.1	0.1
	45	-0.8	-0.8
	60	-1.7	-1.7
	75	-2.2	-2.2
	90	-2.2	-2.2
	105	-1.7	-1.7
	120	-0.8	-0.8
	135	-0.6	-0.6
	150	-0.5	-0.5
	165	-0.5	-0.5
	180	-0.5	-0.5
	195	-0.5	-0.5
	210	-0.5	-0.5
	225	-0.6	-0.6
	240	-0.8	-0.8
	255	-1.7	-1.7
	270	-2.2	-2.2
	285	-2.2	-2.2
	300	-1.7	-1.7
	315	-0.8	-0.8
	330	0.1	0.1
	345	0.8	0.8
	Internal Pressure Coefficient :		
	Refer Clause 6.2.3.1 (IS: 875 (Part-3) - 1987)		



PROJECT:	Providing drinking water to habitations in Komarambheem-Asifabad Segment in Adilabad District	DOCUMENT NO. LE150883-C-WS-CW-DC-3003		DATE 24/03/2016		
TITLE:	40 KL Capacity OHBR - 25m staging height	DESIGNED AKHB/RRG	CHECKED RR	PAGE		
	Internal Pressure coefficients for openings not more than 5% (C_{pi}) =	+0.2				
		-0.2				
	Wind Load acting on the shaft (Case-1)					
	θ in degrees	Shaft (C_{pe})	Shaft (C_{pi})	wind force /m ²	$F_{along\ wind}$	$F_{across\ wind}$
	0	1	0.2	1.19	1.19	0
	15	0.8	0.2	0.89	0.86	0.23
	30	0.1	0.2	-0.15	-0.13	-0.075
	45	-0.8	0.2	-1.48	-1.047	-1.047
	60	-1.7	0.2	-2.82	-1.41	-2.442
	75	-2.2	0.2	-3.56	-0.921	-3.439
	90	-2.2	0.2	-3.56	0	-3.56
	105	-1.7	0.2	-2.82	0.73	-2.724
	120	-0.8	0.2	-1.48	0.74	-1.282
	135	-0.6	0.2	-1.19	0.841	-0.841
	150	-0.5	0.2	-1.04	0.901	-0.52
	165	-0.5	0.2	-1.04	1.005	-0.269
	180	-0.5	0.2	-1.04	1.04	0
	195	-0.5	0.2	-1.04	1.005	0.269
	210	-0.5	0.2	-1.04	0.901	0.52
	225	-0.6	0.2	-1.19	0.841	0.841
	240	-0.8	0.2	-1.48	0.74	1.282
	255	-1.7	0.2	-2.82	0.73	2.724
	270	-2.2	0.2	-3.56	0	3.56
	285	-2.2	0.2	-3.56	-0.921	3.439
	300	-1.7	0.2	-2.82	-1.41	2.442
	315	-0.8	0.2	-1.48	-1.047	1.047
	330	0.1	0.2	-0.15	-0.13	0.075
	345	0.8	0.2	0.89	0.86	-0.23

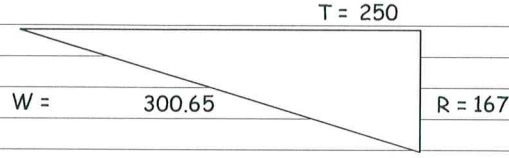
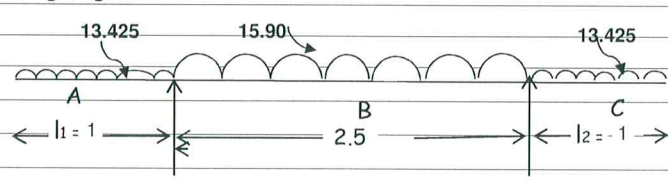

PROJECT:	Providing drinking water to habitations in Komarambheem-Asifabad Segment in Adilabad District	DOCUMENT NO. LE150883-C-WS-CW-DC-3003		DATE 24/03/2016		
TITLE:	40 KL Capacity OHBR - 25m staging height	DESIGNED AKHB/RRG	CHECKED RR	PAGE		
		SUM =		5.37 0		
	Wind Load acting on the shaft (Case-2)					
	θ in degrees	Shaft (C_{pe})	Shaft (C_{pi})	wind force /m ²	$F_{along\ wind}$	$F_{across\ wind}$
	0	1	-0.2	1.78	1.78	0
	15	0.8	-0.2	1.48	1.43	0.383
	30	0.1	-0.2	0.45	0.39	0.225
	45	-0.8	-0.2	-0.89	-0.629	-0.629
	60	-1.7	-0.2	-2.23	-1.115	-1.931
	75	-2.2	-0.2	-2.97	-0.769	-2.869
	90	-2.2	-0.2	-2.97	0	-2.97
	105	-1.7	-0.2	-2.23	0.577	-2.154
	120	-0.8	-0.2	-0.89	0.445	-0.771
	135	-0.6	-0.2	-0.59	0.417	-0.417
	150	-0.5	-0.2	-0.45	0.39	-0.225
	165	-0.5	-0.2	-0.45	0.435	-0.116
	180	-0.5	-0.2	-0.45	0.45	0
	195	-0.5	-0.2	-0.45	0.435	0.116
	210	-0.5	-0.2	-0.45	0.39	0.225
	225	-0.6	-0.2	-0.59	0.417	0.417
	240	-0.8	-0.2	-0.89	0.445	0.771
	255	-1.7	-0.2	-2.23	0.577	2.154
	270	-2.2	-0.2	-2.97	0	2.97
	285	-2.2	-0.2	-2.97	-0.769	2.869
	300	-1.7	-0.2	-2.23	-1.115	1.931
	315	-0.8	-0.2	-0.89	-0.629	0.629
	330	0.1	-0.2	0.45	0.39	-0.225
	345	0.8	-0.2	1.48	1.43	-0.383
				Σ	5.37	0

	LARSEN & TOUBRO LIMITED		23	
	Water, Smart World & Communication IC			
	PROJECT :	Providing drinking water to habitations in Komarambheem-Asifabad Segment in Adilabad District	DOCUMENT NO. LE150883-C-WS-CW-DC-3005	DATE 24/03/16
		TITLE :	40 KL Capacity OHBR	PAGE
		DESIGNED AKHB/RRG	CHECKED RR	
DESIGN OF STAIR CASE				
DESIGN OF STAIR CASE				
* Maximum span of flight is designed and the same reinforcement is provided for all flights and landing slab.				
Design data :				
	f_{ck}	=	25 N/mm ²	
	f_y	=	500 N/mm ²	
	Tread , T	=	250 mm	
	Rise , R	=	167 mm	
	Thickness of Waist slab , D	=	150 mm	
		T = 250		
	W = 300.65		R = 167	
				
Dead load :				
On landing area,	Self wt.of slab	=	3.75 KN/m ²	
	Finish load	=	1.2 KN/m ²	
	Total dead load	=	4.95 KN/m ²	
On Stair area,				
	Flight load = $1/T (D * W + T * R / 2) * 25$			
	= $1/0.25 (0.15 * 0.30 + 0.25 * 0.17 / 2) * 25$			
		=	6.60 KN/mm ²	
	Span for stair area		2.5 m	
	Span for landing area	=		
		l_1 =	1 m	
		l_2 =	1 m	
	Clause 33.1., IS : 456, Effective span, ES = A + B + C =			
			2.5 m	
Live load :				
	Live on landing & stair area	=	4 KN/m ²	
Factored loads,				
	On landing area,	= $1.5 * (DL + LL)$		
		=	13.43 KN/m ²	
	On stair area,	= $1.5 * (DL + LL)$		
		=	15.90 KN/m ²	
Loading diagram ,				
				
From staad				
	R_a	=	33.33 KN	
From staad	R_b	=	33.33 KN	
	Maximum B.M.			
	M_u	=	7.00 KN-m	

 LARSEN & TOUBRO LIMITED Water, Smart World & Communication IC 24	PROJECT : Providing drinking water to habitations in Komarambheem-Asifabad Segment in Adilabad District		DOCUMENT NO. LE150883-C-WS-CW-DC-3005		DATE 24/03/16
	TITLE : 40 KL Capacity OHBR		DESIGNED AKHB/RRG	CHECKED RR	PAGE
	Clear cover in mm = 30 mm		Assuming dia of bar as = 10 mm		Effective depth, d = 115 mm
	Table , SP : 16		Reinforcement :		
		Mu/bd^2 =	0.53 N/mm ²		
		pt =	0.12 %		
		$Ast(req)$ =	143.51 mm ²		
Required 10 Dia. @				547 mm c/c	
Provide 10 Dia. @				125 mm c/c	
therefore,					
		$pt(prov)$ =	0.55 %		
		$Ast(prov)$ =	628.3 mm ²		
Minimum reinforcement required		$= (0.12/100) * 1000 * 150$		187.2 mm ²	
Provide 8 mm dia 200 mm spacing c/c				251.2 mm ²	
Reinforcement provided					
		$pt(prov)$ =	0.17 %		
“Designs Vetted” Check for shear :					
		Actual shear stress, V_u =	33.33 KN		
		T_v =	0.29 N/mm ²		
		for pt =	0.55		
		Allowable shear stress, T_c =	0.507 N/mm ²		
				$> T_v$	
		NO SHEAR REINFORCEMENT IS REQUIRED			
Check for deflection :					
(From IS:456:2000 clause 23.2)					
Allowable span /depth ratio =				20.00	
% of tension reinforcement =				0.55	
$fs = 0.58 * 415 * (143.51 / 628.32)$ =				54.98	
From Fig 4 Modification factor for tension R_{ft} (Mft) =				2.00	
From Fig 5 Modification factor for tension R_{ft} (Mfc) =				1.00	
Modified span /depth ratio = $l/d \times M_{ft} \times M_{fc}$ =				40.00	
Actual span/depth ratio =		$2.5 * 1000 / 115$		21.74	
Actual span/depth ratio < Modified span/depth ratio =				safe	

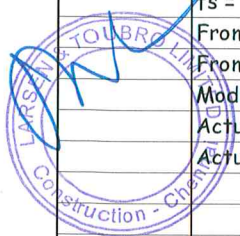
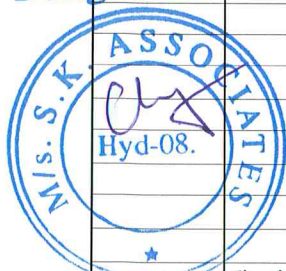

[Signature]
Asst. Executive Engineer
TDWSP Asifabad

[Signature]
Dy. Executive Engineer
TDWSP Asifabad

[Signature]
Executive Engineer
TDWSP Asifabad

APPROVED

SE, NIRMAL





LARSEN & TOUBRO LIMITED
Water, Smart World & Communication IC

PROJECT:	Providing drinking water to habitations in Komarambheem-Asifabad Segment in Adilabad District	DOCUMENT NO.		DATE
		LE150863-C-WS-CW-DC-3003		07-Apr-2016
TITLE :	40 KL Capacity OHBR - 25m staging height	DESIGNED AKHB/RRG	CHECKED RR	PAGE

APPENDIX

(1) Stability Check - Tank empty conditon			
Wind force			155.45 kN
Moment due to wind force			2021.53 kN-m
Seismic force			122.53 kN
Moment due to seismic force			3357.42 kN-m
Max. horizontal force			155.45 kN
Max. overturning moment = OM			3357.42 kN-m
Total vertical DL			
=(Top container(without water) + shaft + stair case + raft + earth inside and outside)			7468.12 kN
	0.9 DL	=0.9 x 7468.12	6721.31 kN
Restoring moment = RM	=DL x (raft dia)/2	=7468.12 x 8.1/2	30245.88 kN-m
Check for safety against overturning			
Factor of Safety	=OM/RM	= 3357.42/30245.88 =	9.01
>1.5 safe Ok			
Check for safety against sliding			
Factor of Safety	=(0.9DL x μ)/(Max horizontal force)		=6721x0.4/155 17.30
>1.25 safe Ok			
(2) Stability Check - Tank full conditon			
Seismic force			154.45 kN
Moment due to seismic force			4231.94 kN-m
Max. horizontal force			155.45 kN
Max. overturning moment = OM			4231.94 kN-m
Total vertical DL			
=(Top container (with water) + shaft + stair case + raft + earth inside and outside)			7905.83 kN
	0.9 DL	=0.9 x 7905.83	7115.25 kN
Restoring moment = RM	=DL x (raft dia)/2	=7905.83 x 8.1/2	32018.62 kN-m
Check for safety against overturning			
Factor of Safety	=OM/RM	= 4231.94/32018.62 =	7.57
>1.5 safe Ok			
Check for safety against sliding			
Factor of Safety	=(0.9DL x μ)/(Max horizontal force)		=7115x0.4/155 18.31
>1.25 safe Ok			

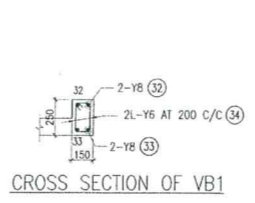
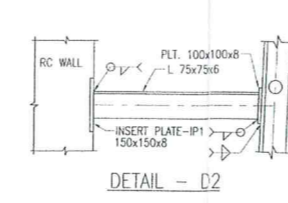
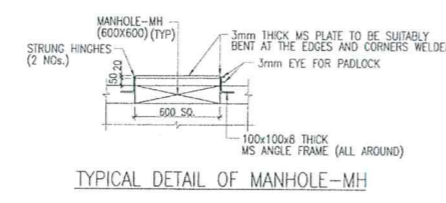
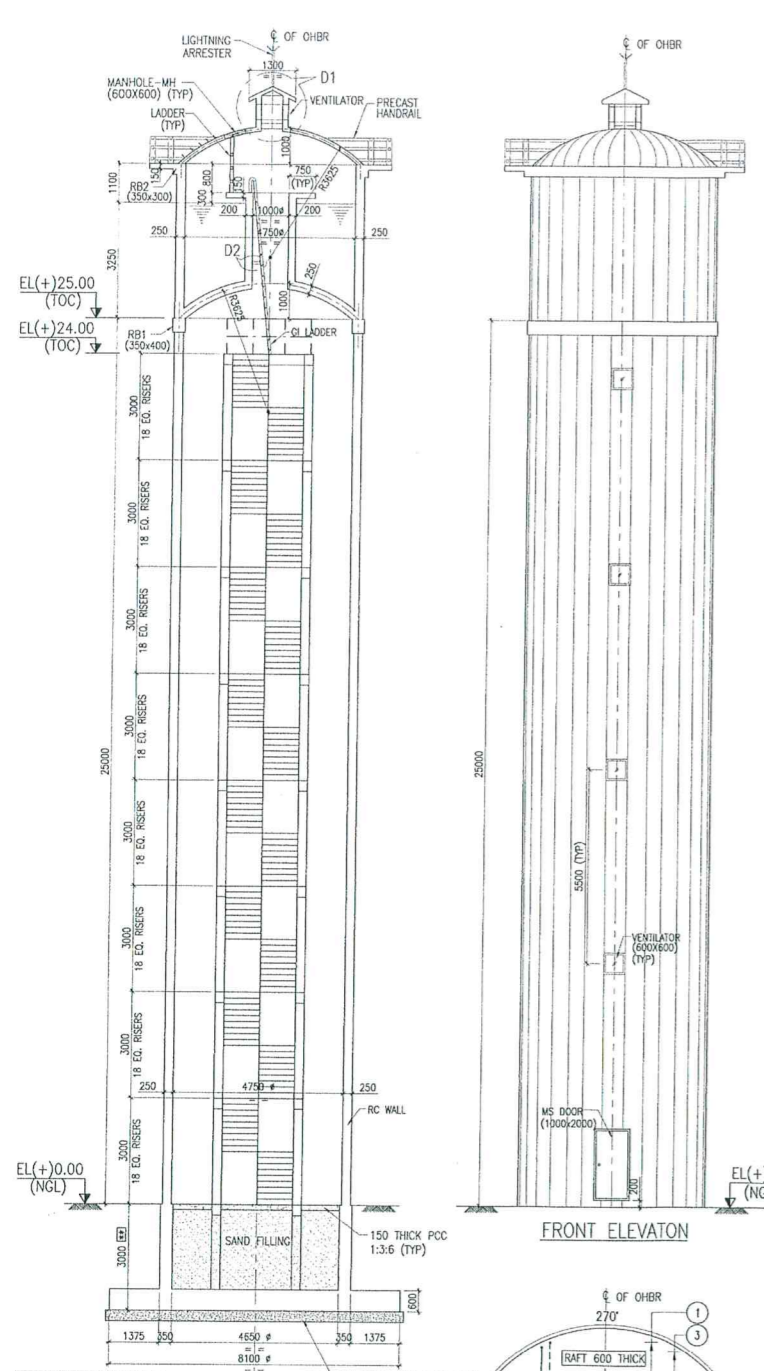

SCHEDULE OF COLUMNS:

COLUMN MARKED	C1	VC1
TOP OF COLUMN	EL(+24.000)	TOP OF SLAB
VERTICAL REINF.	4 NOS. Y16 (C)	4 NOS. Y8 (C)
TIES	Y8 AT 200 C/C (1 TIE PER SET)	Y6 AT 200 C/C (1 TIE PER SET)
CROSS SECTION OF COLUMN		
COLUMN SIZE	250 x 250	150 x 150
COLUMN STARTING LEVEL	TOP OF THE RAFT	TOP OF THE DOME

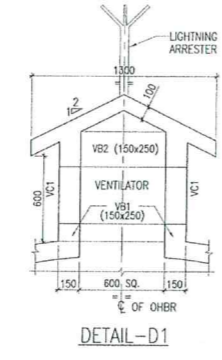
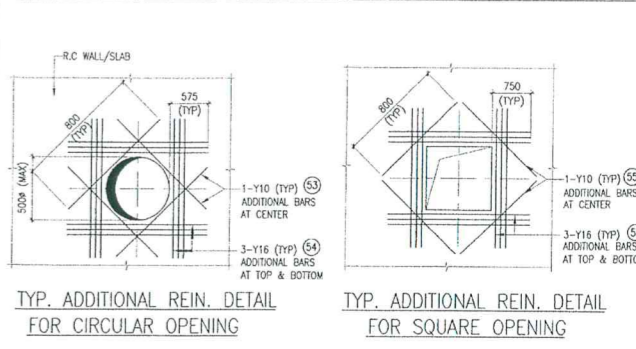

FOR LOCATION AND SIZE OF INLET, OUTLET, SCOUR & OVERFLOW PIPES REFER APPROVED G.A DRAWING.

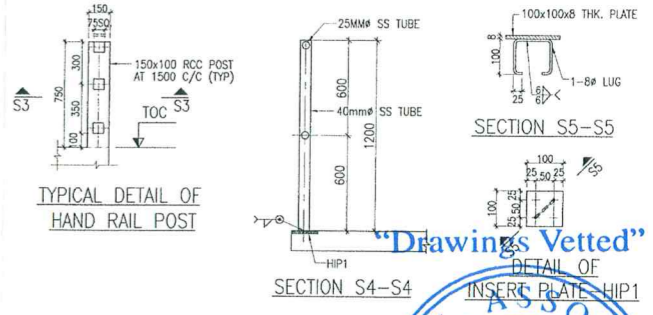
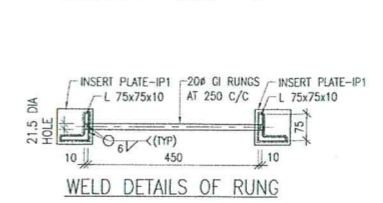
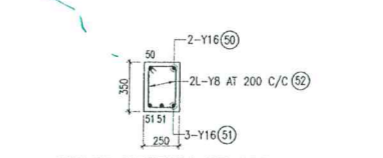
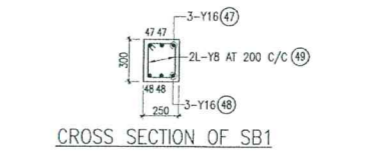
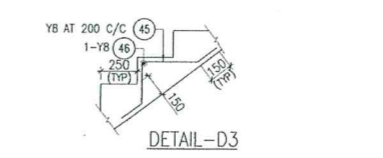
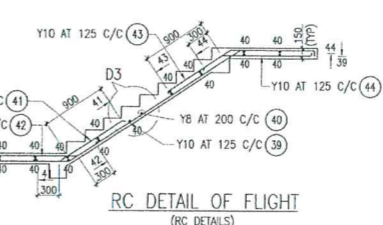
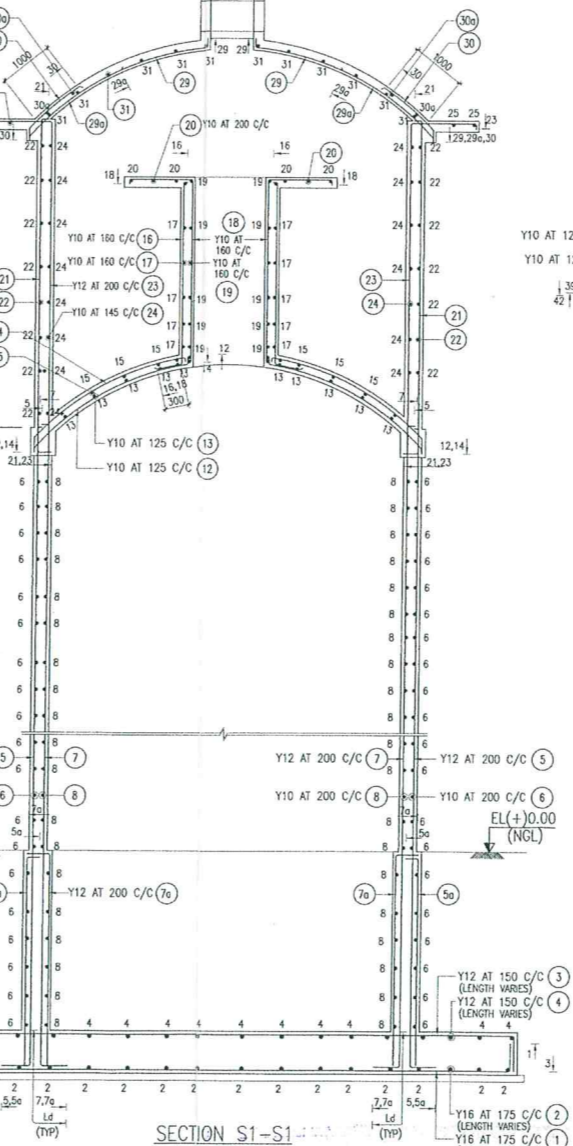
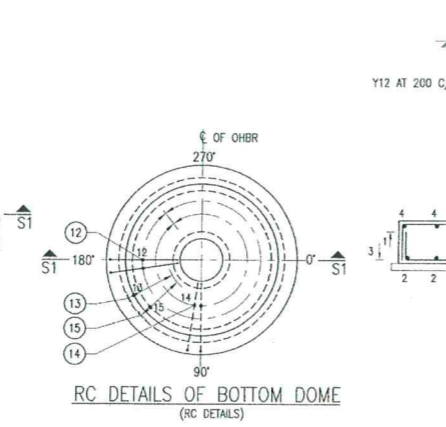
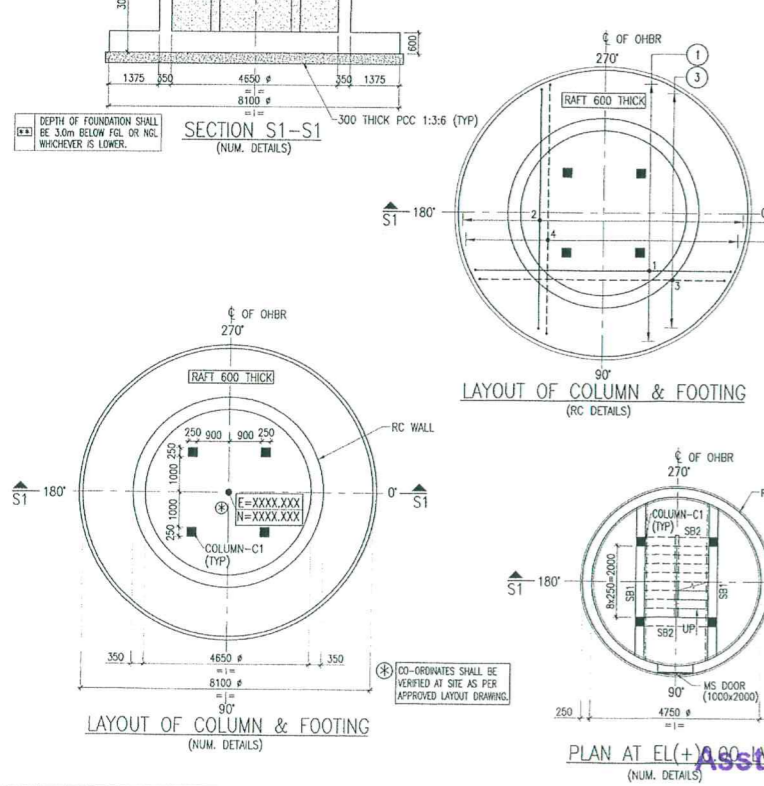
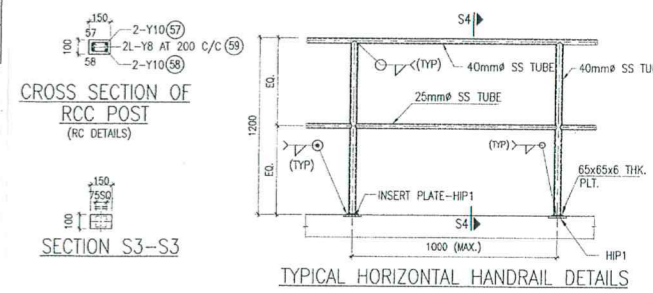

- LEGEND:**
 NGL : NATURAL GROUND LEVEL
 TOC : TOP OF CONCRETE
- NOTES:-**
- ALL DIMENSIONS ARE IN mm & ALL LEVELS SHALL BE IN METRES.
 - GRADE OF CONCRETE SHALL BE M30 - 43 GRADE CEMENT, 20mm DOWN SIZE AGGREGATE WITH MINIMUM CEMENT CONTENT OF 320 kg/cum.
 - Y INDICATES HYSD BARS OF GRADE Fe500 CONFORMING TO IS: 1786-1985.
 - CLEAR COVER TO MAIN REINFORCEMENT SHALL BE :
 - a) RAFT = 50mm
 - b) BEAMS (ALL ROUND) = 30mm
 - c) COLUMNS = 40mm
 - d) SHAFT = 30mm
 - e) WALL = 30mm (FREE FACE), 45mm (WATER FACE)
 - f) TOP DOME = 30mm
 - g) BOTTOM DOME = 30mm (FREE FACE), 45mm (WATER FACE)
 - ALL LAPS SHALL BE 41 TIMES DIA OF BAR AND SHALL BE STAGGERED.
 - THREE COATS OF EPOXY PAINT TO INNER SURFACE OF THE RESERVOIR INCLUDING ROOF AND 2 COATS OF WEATHER PROOF EMULSION PAINTING FOR EXTERNAL SURFACES.
 - SAFE BEARING CAPACITY OF SOIL IS CONSIDERED AS 15T/Sqm.

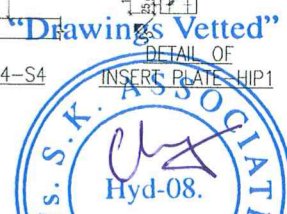

APPROVED
 Executive Engineer
 SE, NIRMAL
 TDWSP Asifabad

Asst. Executive Engineer
 TDWSP Asifabad

Dy. Executive Engineer
 TDWSP Asifabad

REV. NO.	DESCRIPTION	DESIGNED	DRAWN	CHECKED	APPROVED
A	FOR APPROVAL				

L&T Construction
 Water, Smart world & Communication

CLIENT: GOVERNMENT OF TELANGANA
 RURAL WATER SUPPLY AND SANITATION DEPARTMENT

PROJECT: PROVIDING DRINKING WATER TO HABITATIONS IN KOMARABIDDEM, ASIFABAD SEGMENT IN ADILABAD DISTRICT

SUPPLIER/CONTRACTOR: **L&T Construction**
 Water & Effluent Treatment SBG

JOB No.: LE150883

NAME	SIGN	DATE
DSGN	AH/B	24.03.2016
DRWN	M/S	29.03.2016
CHKD	RR	30.03.2016
APPD	BRJ	31.03.2016

TITLE: 40 KL CAPACITY OHBR
 25m STAGING HEIGHT
 NUMERATION & RC DETAILS

SCALE: 1:100, 1:50 & 1:25
 PROJECTION:

CHECKED BY	SIGN	DATE
CIVIL & STRUCTURAL	-	-
PROCESS	-	-
MECHANICAL	-	-
ELECTRICAL	-	-
INSTRUMENTATION	-	-

RELEASED FOR: PRELIMINARY TENDER INFORMATION APPROVAL CONSTRUCTION

GEOTECHNICAL INVESTIGATION REPORT

TELANGANA DRINKING WATER SUPPLY PROJECT

KOMARAM BHEEM - ASIFABAD- SEGMENT 22

ASIFABAD , ADILABAD DISTRICT

40 KL OHBR -BPT AT NAGAGUDA AT TRIYANI (M)

CONTRACTOR :

**M/s. LARSEN& TOUBRO LIMITED,L&T CONSTRUCTION,
WATER & EFFLUENT TREATMENT SBG, CHENNAI**

Drilling By:

M/s. ANJI DRILLING & GROUTING WORKS

Report Prepared by

DR. D. BABU RAO,

M.E.(IIT,Roorkee), Ph.D.(USA), MIGS

MCH Panellist No. 2490 /TP/2000-2

GEOTECHNOLOGIES

CONSULTING GEO TECHNICAL ENGINEER

FORMER PROFESSOR &HEAD OF CIVIL ENGINEERING

OSMANIA UNIVERSITY

Phone: 6663 8830, Mobile : 98490 – 39337

Email : dbaburao2000@yahoo.com

TELANGANA DRINKING WATER SUPPLY PROJECT

40 KL OHBR – BPT AT NAGAGUDA AT TRIYANI (M) IN ADILABAD DT.

1. INTRODUCTION

M/s. L & T Construction, Water & Effluent Treatment is proposing to construct 40 KL OHBR – BPT at Sirikonda (V), Indravelli (M). The work is taken up under Segment 22, Komaram Bheem Project, TDWSP, in Adilabad Dt.

The present Report presents the results of (1) Bore hole.

M/S Anji Drilling & Grouting works; Anantapur has carried out the drilling of bore holes, collection of soil and rock samples and conduct of Standard Penetration Tests at different levels in the respective bore holes at the proposed site.

Analysis of borehole data, Laboratory tests and geotechnical investigation report have been made by Prof. D Babu Rao, ME (IIT,R), Ph.D. (USA), MIGS, Empanelled Consulting Geo technical Engineer & Director, Geo technologies, Former Professor of Civil Engineering, Osmania University.

2. SCOPE OF WORK

The following is the scope of work of M/s. Anji Drilling and Grouting Works:

- Drilling Borehole at (1) location for 40 KL OHBR – BPT at Sirikonda (V), Indravelli (M)
- Conducting SPT at regular intervals, where feasible
- Collection of undisturbed / disturbed samples from the Bore holes

DR. D. BABU RAO
M.E., Ph.D.(USA)
Consulting Geotechnical Engineer

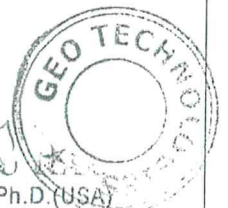

- Preparation of Technical Report recommending suitable foundations and safe bearing capacity

Following is the scope of work of Prof. D Babu Rao ,

Testing of soil samples in the Laboratory

Preparation of Technical Report

3. SUB SOIL INVESTIGATION

The sub soil investigation was carried out to determine:

Nature of sub stratum and engineering properties of sub strata which may affect the mode of construction of the proposed work.

FIELD INVESTIGATION PROCEDURE:

The following technique is adopted for sub soil investigations.

a) BORINGS:

Rotary Drilling was done using TC / Diamond bits. The size of the casing used was 125 to 75 mm, yielding samples of NX size.

TC bits were employed for the overburden, and Impregnated Diamond Core bits were used for rock formation.

Drilling was performed on 29 Jan ,2016.

The following relevant data was recorded during Rotary drilling operations.

- Nature of strata
- Details of samples

Dr. D. BABU RAO
M.E., Ph.D.(USA)
Consulting Geotechnical Engineer



- Core Recovery (CR)
- Rock Quality Designation (RQD)

b) STANDARD PENETRATION TEST (SPT):



SPT split spoon sampler of standard dimensions was driven into the soil from the borehole bottom using 63.5 kg hammer with a fall of 75 cm height. The SPT weight was lifted to the specified height and allowed to fall freely on the anvil with the use of cat-head winch with one to one and half turn of the drum. Blow counts for the penetration of every 15 cm were recorded and the 'N' value is reported as the blow counts for 30 cm penetration of the sampler excluding the first 15 cm penetration as seating drive.

When the number of blows exceeded 50 to penetrate the first or second 15 cm length of the sampler, the SPT 'N' is regarded as more than 100 as described in IS 2131 - 1981. The test is terminated in such case and a record of the penetration of the sampler under 50 blows is made. SPT refusal is recorded when there is no penetration of the sampler at any stage and also when a rebound of the sounding system is recorded. These tests were conducted at close intervals of 1.0m so that a continuous SPT 'N' profile is available.

Disturbed soil collected in the SPT sampler was preserved in polythene covers and transported to the laboratory. Additional polythene cover was used to prevent the loss of moisture during the transit period.

c) DEPTH OF BORING: The depth of the Bore hole was as follows:

BH No	Drilled depth
1	6 m



Dr. D. BABU RAO
 M.E., Ph.D.(USA)
 Consulting Geotechnical Engineer

d) LOG OF BORE HOLE:

All the results obtained from the field operations are presented in Log of Bore hole in Fig. 1 .

4. LABORATORY TESTING:

The laboratory tests are conducted in the laboratory of Geotechnologies, Hyderabad, an ISO- 9000 approved Laboratory.

From GL to 4.5 m , S D R was seen. N value exceeded 100 blows

(Refusal) ..

The following tests were conducted on cores from hard rock below 4.5 m depth.:

- Unconfined compressive strength (as per IS: 9143)

Table 1 gives the properties of Cores in hard rock.

5. SUB SOIL PROFILE

Based on Field and Laboratory tests, the following idealized sub soil profile is evolved.

Depth	Strata	N value
0 –4.5 m	S D R	>100 Small cores
4.5 – 6 m	Hard Rock	Cores

. In Hard rock, no SPT can be conducted. However, in SDR strata, SPT can be conducted with N values tending to be 'refusal'. This is the criterion for distinguishing between Soft rock /Weathered rock and Hard rock.

Dr. D. NABU
M.E., Ph.D.(USA)
Consulting Geotechnical Engineer

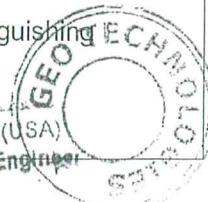

8.0 RECOMMENDATIONS

Based on Field Investigations and laboratory testing, the following Recommendations are made for construction of 40 KL OHBR – BPT at Nagaguda Triyani (M).

- a) Open foundations resting at 2 m below GL ,are recommended. The structure is likely to result in saturation and inundation of the sub soil during long – time operation,
- b) SBC is recommended as follows :

Location		BH 1
S. No.	Depth (m)	Recommended SBC t/ sq m
1	2.0	25
2	3.0	30
3	4.0	35

- c) The actual size of foundations will be based on loads from the superstructure.

For ANJI DRILLING AND GROUTING WORKS

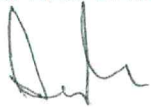

(DR. D. BABU RAO)

M. E(IIT,R), Ph. D. (USA), MIGS

Former Professor of Civil Engineering

Consulting Geotechnical Engineer

MCH Panelist No. 2490/TP/2000-2

Dr. D. BABU RAO
M.E., Ph.D.(USA)
Consulting Geotechnical Engineer



TELANGANA DRINKING WATER SUPPLY PROJECT

FIG 1 : Record of Boring, Bore Hole No : 1



40 KL OHBR – BPT AT NAGAGUDA AT TRIYANI (M) IN ADILABAD DT.

Type of Boring: Core drilling

Dia of Boring: NX

Date : 29 Jan 2016

Drilled depth : 6 m

Depth, m	Profile	Soil	Sample Depth m	N value	CR, %	RQD%	
0		SDR	0	>100		-	
1.0			1.5	>100		-	
2.0							
3.0			3.0	>100		-	
4.0		Hard rock	4.5		21	-	
5.0							
6.0							
7.0							
8.0							
9.0							
10.0							
11.0							
12.0							
13.0							
14.0							
15.0							
16.0							



DR. D. KANDU
M.E., Ph.D.(USA)
Consulting Geotechnical Engineer





TABLE 1 : RESULTS OF TESTS ON ROCK SAMPLES

40 KL OHBR – BPT AT NAGAGUDA AT TRIYANI (M) IN ADILABAD DT.

BH No.	Depth, m	Specific gravity	Porosity %	Water absorption %	UCS Kg / sq cm
1	4.8	2.72	4.2	3.1	-

NOTES : Where core Samples are less than 100 mm long, UCS tests are not conducted.

Dr. D. BABU RAO
M.E., Ph.D.(USA)
Consulting Geotechnical Engineer



APPENDIX

CALCULATION OF SBC

40 KL OHBR – BPT AT NAGAGUDA AT TRIYANI (M) IN ADILABAD DT.

TYPICAL CALCULATIONS FOR OPEN FOUNDATIONS AT 2 M DEPTH

a) Shear Criterion :

Assumed value of $N = 50$

Assumed width of foundation = 4 m

Assumed depth of foundation = 1,5 m inside rock

Correction factors $R_q = R_r = 0.5$

With a F.S. of 3.0 ,

Allowable $q = 1 / 18 [2 N^2 B R_r + 6 (100 + N^2) D R_q] = 1205 \text{ kN / sq m}$

b) Settlement Criterion :

For permissible settlement of 40 mm,

Allowable Bearing Pressure = $12.25 N (B + 0.3) / B$

= 658 kN / sq m

Adopt 250 kN / sq m .

c) As per IS : 8009 (Fig. 2) Code of Practice for calculation of settlements of foundations:

For $N = 50, B = 4,$

Settlement = 0.0045 m per unit pressure of 1 kg / sq cm



Dr. D. BABU RAO
M.E., Ph.D.(USA)
Consulting Geotechnical Engineer

For a pressure of 25 t/sq m,

Settlement = $0.0025 \times 4.5 \times 1000 = 11.25 \text{ mm OK}$

d) As per IS : 12070 (Code of Practice for Design & Construction of Shallow Foundations on Rocks) :

Weathered and disintegrated rock is treated under Classification No. V of Table 3 of the Code

For this *very poor* rock , net allowable bearing pressure is recommended as 25 t / sq m , for settlement less than 12 mm.

Keeping the above considerations in view, Recommended Safe Bearing Capacity is 25 t per sq m



DR. D. BABU RAO
M.E., Ph.D.(USA)

Consulting Geotechnical Engineer

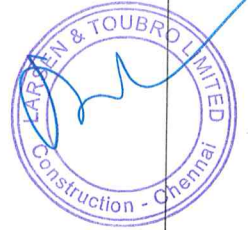

Asst. Executive Engineer
TDWSP Asifabad

Dy. Executive Engineer
TDWSP Asifabad

Executive Engineer
TDWSP Asifabad